

A HYBRID AGENT-BASED AND DIFFERENTIAL EQUATIONS MODEL FOR SIMULATING ANTIBIOTIC RESISTANCE IN A HOSPITAL WARD

Lester Caudill
Barry Lawson

Department of Mathematics and Computer Science
University of Richmond
Richmond, VA 23173, USA

ABSTRACT

Serious infections due to antibiotic-resistant bacteria are pervasive, and of particular concern within hospital units due to frequent interaction among health-care workers and patients. Such nosocomial infections are difficult to eliminate because of inconsistent disinfection procedures and frequent interactions among infected persons, and because ill-chosen antibiotic treatment strategies can lead to a growth of resistant bacterial strains. Clinical studies to address these concerns have several issues, but chief among them are the effects on the patients involved. Realistic simulation models offer an attractive alternative. This paper presents a hybrid simulation model of antibiotic resistant infections in a hospital ward, combining agent-based simulation to model the inter-host interactions of patients and health-care workers with a detailed differential equations and probabilistic model of intra-host bacterial and antibiotic dynamics. Initial results to benchmark the model demonstrate realistic behavior and suggest promising extensions to achieve a highly-complex yet accurate mechanism for testing antibiotic strategies.

1 INTRODUCTION

The status of health-care associated infections (HAI), also known as *nosocomial infections*, as a serious health threat is well-documented. The Centers for Disease Control and Prevention (CDC) reports that approximately 1.7 million HAIs occur in American hospitals each year, resulting in approximately 99,000 deaths and \$20 billion in associated healthcare costs (Klevens et al. 2007). The threat of HAIs is greatly compounded by the rise of antibiotic resistance among many of the more dangerous human pathogens. Such resistance often results in increased treatment failures, which in turn lead to infections that are both more deadly and more costly than their antibiotic-sensitive counterparts (Stein 2005). Moreover, the problem is widespread — the CDC reports that more than 70% of the bacteria that cause HAIs are resistant to at least one of the antibiotics most commonly used to treat them, and, according to one study, nearly 20% of pathogens from HAIs are multi-drug resistant phenotypes (Sievert et al. 2013).

In response to this public health threat, a number of individuals and groups have proposed strategies to control the rise and spread of antibiotic resistance in hospital pathogens (Goldmann et al. 1996, Spellberg et al. 2008). Some of these strategies focus on active management of antibiotic usage because of the ability of the drugs to impact the natural selection process at the bacterial level. Many of the suggested strategies involve careful stewardship over the use of antibiotics (Farr et al. 2001), including cycling, substitution, and combination therapy.

Careful testing of the relative effectiveness of these antibiotic management strategies is needed, but only a very small number of these proposed strategies have been hospital-tested with regard to their impact on antibiotic-resistant infections, primarily because of (1) the large number of factors that can influence the infection dynamics, and (2) the health risks and ethical issues inherent in any controlled study involving

treatment of humans. A mathematical and computational model simulating infection dynamics in a hospital unit offers the potential to run controlled experiments specifically designed to test the relative merits of each management strategy in an inexpensive way that does not place patients at risk, and may even identify novel strategies for minimizing the threat of antibiotic-resistant infections.

When considering any mathematical or computer simulation model of antibiotic-resistant dynamics, there are two distinct levels that are important to capture. *Intra-host dynamics* refers to bacterial-level processes that take place inside each individual human host and includes bacterial population dynamics (reproduction and natural death), changes in resistance due to genetic mutations, plasmid-mediated resistance, pharmacokinetic and pharmacodynamic properties of antibiotics, antibiotic-bacteria interactions, bacterial interactions with the host immune system, interactions between bacterial strains with different resistance profiles, and interaction between bacterial species. *Inter-host dynamics* refers to interactions at the human-level, principally the transfer of bacteria between individuals, and includes different types of interactions among patients and health-care workers (HCWs), and antibiotic treatment decisions and applications.

This work aims to provide a highly realistic model for simulating HCW, patient, bacterial, and antibiotic dynamics as they relate to the rise and spread of antibiotic-resistant HAIs, offering the ability to carefully test existing antibiotic management strategies and, possibly, to generate new strategies. Our model:

- combines intra-host dynamics and inter-host dynamics into a single, unified, realistic model that is sufficiently flexible to permit simulation of many of the management strategies listed above;
- naturally includes a heterogeneous population of individuals in the hospital ward, unlike traditional SIR-type approaches;
- allows the inclusion of many bacterial species — with parameter values that reflect differences among them — and a range of strains within each species, each with distinct resistance profiles and multiple levels of resistance;
- permits genetic changes within bacteria to alter antibiotic resistance profiles;
- permits a wide range of antibiotic choices, with pharmacokinetic (and other) parameter values that reflect the behavior of each; and
- allows for multiple categories of host colonization or infection (i.e., more than simply “colonized” or “uncolonized”), with different likelihood of spread between hosts.

This paper describes the combination of the intra- and inter-host models, and provides preliminary results demonstrating the ability of the hybrid model to capture the complex dynamics associated with antibiotic resistant HAIs within a single hospital ward.

The remainder of this paper is organized as follows. Section 2 discusses related work. The inter-host and intra-host models are discussed in Section 3. Section 4 presents preliminary experiments and results using our model, and Section 5 provides conclusions and future directions.

2 RELATED WORK

Models addressing antibiotic resistance now generally fall into one of two categories: compartmental (population dynamics) models or agent-based simulation models. By far the most common approach is to model infection dynamics using the so-called SIR models, in which patient (and HCW, if included) populations are divided into categories (compartments), with underlying systems of differential equations describing rates of transition from one category to another, e.g., recent works that focus on control strategies within hospital units (D’Agata et al. 2005), facilities other than hospitals (Chamchod and Ruan 2012b), or to suggest coordination at a regional level (Smith et al. 2004). One primary drawback of compartmental models is the frequent assumption that each compartment consists of a set of homogeneous individuals. Incorporating complex transmission dynamics between patients and HCWs is limited with this approach, although some heterogeneity can be introduced (Bootsma et al. 2006). In addition, many of the published works thus far have focused primarily on preventative control strategies (e.g., hand hygiene, patient screening,

decolonization), although a few recent studies have focused on treatment and antibiotic history (Chamchod and Ruan 2012a) or on quantifying the contribution of antibiotic exposure (D'Agata et al. 2005).

Because of the ability to easily model heterogeneous populations, agent-based simulation models apply well in this context. Similar to the SIR-model work, most agent-based models focus on simulating control strategies (Barnes et al. 2010, Meng et al. 2010). One recent agent-based approach focuses on community-associated antibiotic resistance (Macal et al. 2012), an even more challenging problem that requires modeling dynamics throughout the entire community. Perhaps the closest related work is the combination of agent-based simulation with loosely-coupled system dynamics (Djanatliev et al. 2012), although the application to mobile stroke units is different than our focus, and modeling population and disease dynamics using system dynamics differs from our in-host model.

The contribution of our work lies primarily in the tight integration of agent-based simulation, which naturally models heterogeneous populations and allows for modeling complex interactions at the human level, with a very detailed differential equations model of in-host bacterial and antibiotic dynamics. Recent work comparing differential equations models with agent-based simulation concludes that the former are more tractable while the latter allow for heterogeneity and complexity (Rahmandad and Sterman 2008). Moreover, a recent call for multi-agent simulation (MAS) (Helbing and Balmelli 2011) points out that these models provide natural heterogeneity, can be easily combined (bridged) with other types of models, and are well suited for detailed hypothesis testing. Our work is therefore timely and appropriate, allowing for careful combination of two generally disparate approaches.

3 HYBRID AGENT-BASED AND DIFFERENTIAL EQUATIONS MODEL

Our approach integrates agent-based simulation, used to model the inter-host dynamics of patients and HCWs, with a detailed differential equations model of the intra-host bacterial and antibiotic dynamics. Each level is discussed in turn below.

3.1 Agent-Based Inter-Host Model

Conceptual Level: The agent-based level of our model facilitates the simulation of interactions among health-care workers (HCWs) and patients. An agent in the model represents either a single health-care worker or a single patient. Each agent has a set of characteristics (data), uniquely populated per agent. These characteristics include blood volume (for computing antibiotic concentrations), a vector characterizing the current bacteria population in the host (referred to as the *bacterial population vector*, or *BPV*, which is described in more detail in Section 3.2), and antibiotic treatment history, and, for HCWs only, a list of assigned patients. Each agent also has a set of behaviors (methods) consistent with the actions of the host being modeled. For example, a HCW has behaviors to model visiting patients on rounds, visiting patients as a result of patient call, and interacting with other health-care workers. Because the interactions in our model are driven primarily by the actions of HCWs, a patient currently has behavior only to model interaction with another patient.

Figure 1 provides a conceptual view of potential agent interactions in our model from a single HCW's perspective. Specifically, when a HCW begins a shift, the HCW may spend non-zero time in preparatory work before moving on to rounds for assigned patients. We presume that an interaction between HCW and patient is non-preemptive, but at any time between rounds visits, a HCW may interact with another HCW (e.g., in the hallway) or with another patient as a result of patient call. After one sequence of rounds is complete, the HCW may spend non-zero time in summary work (e.g., updating charts) before resuming rounds or ending the shift.

Computational Level: Because the intra-host differential equations model was developed in MATLAB, we use the object-oriented programming capabilities of MATLAB to implement the agent-based level of the model. We use an Agent class to model the characteristics and behaviors consistent across all agents, while Patient and HCW classes extend the Agent class for more specific characteristics and behaviors.

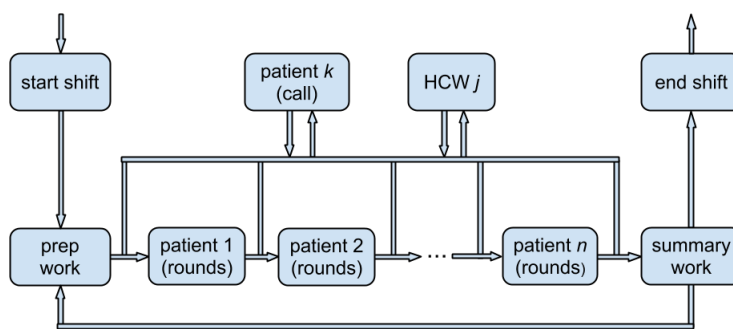

Figure 1: Activity for one health-care worker in the agent-based model.

We use next-event simulation (Leemis and Park 2006) to drive the time evolution of the model. The event types currently include the following: (a) HCW visiting patient on rounds; (b) HCW addressing a patient call; (c) two HCWs interacting; (d) two patients interacting; (e) application of antibiotic to an agent; (f) end of HCW shift; and (g) discharge of a patient.

As is typical with this type of simulation, the event calendar is kept up-to-date with the time of, and reference to, the next event in simulated time for each event type. (Note that each Agent object stores the next event times for each event type for that specific agent, as applicable. The calendar stores only the first in simulated time for each event type.) The simulation progresses by advancing the simulation clock to the most imminent event time, handling that particular event, then scheduling new event(s) for the associated agent, and finally updating the calendar accordingly.

Whenever two agents interact, the agent-based level invokes methods from the differential-equations level to model the dynamics of bacteria and antibiotics within each of the two agents across time (see Section 3.2). This corresponds to event types (a)–(d) above. Whenever an agent is to receive antibiotic treatment, corresponding to event type (e) above, methods from the differential-equations level are again invoked to model the application and dosage of a specific antibiotic. For event type (f), we presume that whenever a HCW’s shift ends, a new HCW immediately starts a shift, accepting all the assigned patients from the exiting HCW. For event type (g), we also presume that patient discharge results in a new patient assigned immediately in the exiting patient’s stead.

3.2 Differential Equations/Probabilistic Intra-Host Model

An important component of our hospital infection model is to simulate the changes in each agent’s internal pathogen population over time, as this drives, among other things, the possibilities of bacterial exchange during agent-interaction events. In light of the goals of this project, it is essential to subdivide an agent’s bacterial population into different sub-populations, so we organize each agent’s bacteria population into a *bacteria population vector*, or *BPV*, which is stored within the agent object.

To realistically model the transfer of bacteria between agents, it is necessary to distinguish between different infection states within each agent. We subdivide each agent’s bacterial population into six *infection categories (I-Cats)*, which reflect six different infection/colonization-states that bear on the spread of infection, as listed in Table 1. With this structure, the possible bacterial exchanges between the two types of agents (patient and HCW) are given in Table 2. (Based on an extensive review of the infectious diseases literature, these possible exchanges are widely accepted. For example, the multiple “yes” entries in row 4 of Table 2(b) reflect the possibility of a HCW with a skin infection spreading that bacteria to patients in multiple ways. By contrast, the “no” entries in row 5 of Table 2(b) reflect the unlikelihood of a HCW with a urinary tract infection spreading that bacteria to patients.) At each agent-interaction event, random deviates are drawn to determine whether transfer between the allowable I-cat-pairings occur. The number of bacteria transferred is also determined randomly.

Table 1: The six “infection categories” (I-Cats), used by the simulation model.

I-Cat	Description	Examples
1	colonization that can be anticipated and addressed	hand or equipment colonization
2	unnoticed colonization — no preemptive action taken	nasal carriage of <i>S. aureus</i>
3	present as part of the agent’s regular microflora	usual gut bacteria
4	can be self-spread, spread directly agent-to-agent, or spread via HCW intervention	skin or respiratory infections
5	can be self-spread or spread via HCW intervention, but not spread directly agent-to-agent	urinary tract infections
6	can be spread via HCW intervention, but not self-spread nor spread directly agent-to-agent	bloodstream infections

Table 2: Summary of the possible bacterial exchanges between agents. In both tables, each row represents one of the I-Cats of the donor agent, and each column represents one of the I-Cats of the recipient agent. Table (a) indicates possible transfers from a patient to a HCW, while table (b) indicates possible transfers from a HCW to a patient. A “yes” indicates that transfer between those two I-Cats is possible. Patient-to-patient and HCW-to-HCW transfers are possible, but their tables are not shown here for brevity.

	I-Cat=1	I-Cat=2	I-Cat=3	I-Cat=4	I-Cat=5	I-Cat=6
I-Cat=1	yes	yes	no	yes	no	no
I-Cat=2	yes	yes	no	yes	no	no
I-Cat=3	yes	yes	no	yes	no	no
I-Cat=4	yes	yes	no	yes	no	no
I-Cat=5	yes	no	no	no	no	no
I-Cat=6	yes	no	no	no	no	no

(a) Patient-to-HCW Transfer

	I-Cat=1	I-Cat=2	I-Cat=3	I-Cat=4	I-Cat=5	I-Cat=6
I-Cat=1	yes	yes	no	yes	yes	yes
I-Cat=2	yes	yes	no	yes	yes	yes
I-Cat=3	no	no	no	no	no	no
I-Cat=4	yes	yes	no	yes	yes	yes
I-Cat=5	no	no	no	no	no	no
I-Cat=6	no	no	no	no	no	no

(b) HCW-to-Patient Transfer

At the start of a simulation run, we select which bacteria species to track, and which antibiotics to use to treat infections. Each of the agent’s six I-Cats are then subdivided to have one subdivision for each bacteria species, resulting in the number of subdivisions being equal to $6 \times (\#species)$. One step further, each of these $6 \times (\#species)$ sub-populations are further subdivided according to the possible antibiotic resistance profiles. To explain what is meant by “resistance profile”, we first note that the resistance-level of a bacterial strain versus a particular antibiotic can be quantified by the notion of *minimum inhibitory concentration* (MIC). The MIC is the minimum concentration of the antibiotic at which the bacteria strain cannot reproduce. Each chosen (for the simulation) bacteria strain will have one MIC value for each of

the chosen antibiotics, and we refer to this set of MIC values as that strain’s *resistance profile*. To make things precise in our model, at the start of each simulation we choose how many levels of resistance (which translate into intervals of MIC values) will be included for each antibiotic. This means there are $(\# \text{resistance levels})^{(\# \text{antibiotics})}$ different resistance profiles for each bacteria species. This results in

$$\text{length of BPV} = 6 \times (\# \text{species}) \times (\# \text{resistance levels})^{(\# \text{antibiotics})}.$$

An illustration of the structure of the BPV, in the case of two bacteria species, two antibiotics, and two resistance-levels, is shown in Figure 2.

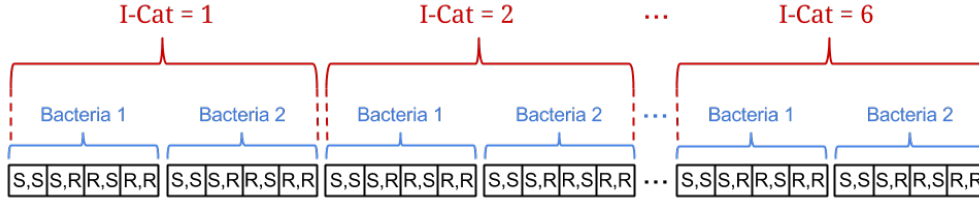

Figure 2: Structure of an agent’s BPV for the case of two bacterial species, two antibiotics, and two resistance-levels. The row of boxes along the bottom represents the BPV. For instance, the sixth entry in the BPV consists of the density of the strain of bacteria #2 in I-Cat #1 that has resistance-level “S” (“susceptible”) for antibiotic #1 and resistance-level “R” (“resistant”) for antibiotic #2.

Within each agent, we use a combination of differential equations models and probabilistic models (with parameters specific to that agent) to simulate the key factors that influence the changes, over time, in the bacteria sub-populations within the agent’s body (i.e., values of the agent’s BPV entries). The differential equations (DE) system consists of one DE for each BPV entry, and models bacterial reproduction, natural death, and death due to the presence of antibiotics. We denote the entries in the agent’s BPV as $P_{i,j,k}$, where i indicates the I-Cat, j indicates the bacteria species, and k indicates the resistance profile. (For example, entry #7 in the BPV in Figure 2 would be $P_{1,2,3}$.) Then, the DE for each $P_{i,j,k}$ in the BPV can be expressed as

$$\frac{dP_{i,j,k}}{dt} = (\text{reproduction}) - (\text{natural death}) - (\text{AB induced death}),$$

which, for our model, takes the form

$$\frac{dP_{i,j,k}}{dt} = a_{i,j,k}P_{i,j,k}(t) - b_{i,j,k}P_{i,j,k}(t) - d_{i,j,k}(t)P_{i,j,k}(t), \quad (1)$$

where $a_{i,j,k}$ and $b_{i,j,k}$ are constants that do not differ between agents, and the function $d_{i,j,k}(t)$ has the form

$$d_{i,j,k}(t) = \begin{cases} 0 & \text{if } C_r(t) \leq MIC_{j,r} \\ \sum_{r=1}^{\# \text{antibiotics}} \frac{\alpha_{i,j,k,r}(C_r(t) - MIC_{j,r})}{\beta_{i,j,k,r} + \gamma_{i,j,k,r}(C_r(t) - MIC_{j,r})} & \text{if } C_r(t) > MIC_{j,r} \end{cases}. \quad (2)$$

In Equation (2), $\alpha_{i,j,k,r}$, $\beta_{i,j,k,r}$, and $\gamma_{i,j,k,r}$ are constants, $C_r(t)$ is the current concentration of antibiotic r , and $MIC_{j,r}$ is the MIC value of antibiotic r versus bacteria species j .

To accurately reflect the rise and spread of antibiotic-resistant members of an agent’s bacterial population, our model must also account for the underlying natural selection dynamics within the bacterial sub-populations. Figure 3 illustrates the process by which improper use of antibiotics (either by using insufficient dosages or by ending treatment before all bacteria are eliminated) can lead to the rise-to-dominance of antibiotic-resistant members of those populations. Key to this process is the occasional appearance of

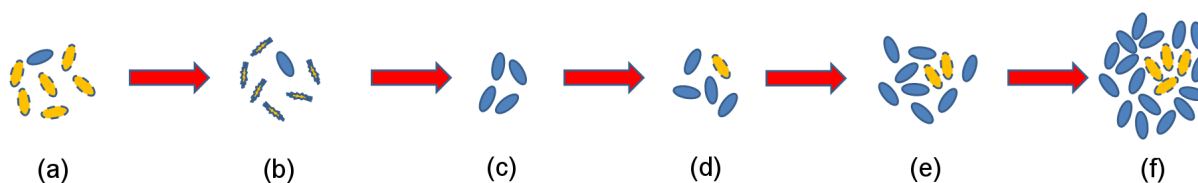

Figure 3: Process by which antibiotic use can lead to an increase in the proportion of a bacterial population that are resistant to that antibiotic: (a) With no antibiotic present, susceptible bacteria (light color) dominate. Random genetic mutations during reproduction yield an occasional antibiotic-resistant mutant (dark color). (b) With antibiotic present, susceptible bacteria are killed while resistant ones survive. (c) With antibiotic present, resistant bacteria continue to live and reproduce, while any susceptible bacteria arising from genetic mutations are killed by the antibiotic, resulting in a purely-resistant population. (d) When antibiotic is removed, the existing resistant population continues to reproduce, resulting in an occasional susceptible mutant which can now survive. (e) After one generation, susceptible and resistant bacteria reproduce. (f) After a short time, resistant bacteria dominate, making the population as a whole more difficult to eradicate with antibiotics.

resistant individuals in the bacterial population, resulting from random genetic mutations arising during reproduction of the susceptible bacteria.

Mutation dynamics are less amenable to differential equations modeling, so we utilize a probabilistic model to allow for the possibility of bacterial genetic mutations (occurring during reproduction) that result in a change in a bacterium’s resistance-profile. When an agent’s BPV is updated (via the system in Equation (1)) from the previous event time to the current time, updating is paused at regular time intervals to allow for some of the newly-created members of the BPV to change from one resistance level to another via mutation. Specifically, for each nonzero sub-population, we draw a random deviate from a suitable binomial distribution. These deviates determine, for each entry in the BPV, how many of the newly-created members of that sub-population will be moved to different resistance-profiles.

4 RESULTS

Before proceeding to our example simulation, we show the results of three proof-of-concept tests using our implementation. In the first, we test our intra-host differential equation system model (1) by creating a single agent, with one bacteria species, one antibiotic, and one resistance-level, resulting in a BPV with six entries, which we set initially to 10, 100, 0, 0, 10^5 , and 0, respectively. The result is a simulation in which neither bacterial transfer (because there is only one agent) nor mutation (because there is only one resistance-level) is possible, effectively isolating the DE model as the only active dynamics. The resulting BPV values over time for the three non-zero I-Cats, in the absence of antibiotic treatment, are illustrated in Figure 4 (blue dashed curves), and given in CFUs (colony-forming units). We compare these results to the exact solutions of the DE system in Equation (1), shown by the red solid curves in the same figure. In each case, point-wise errors are on the order of 10^{-11} , which demonstrates good agreement.

Next, we test the bacterial transfer feature of our implementation by introducing a second agent into the above setting, so that we have one patient and one HCW. In order to isolate the bacterial transfers, we set the first entry in the HCW to 10^4 , and the remaining entries in both agents to 0. We turn off the birth and death dynamics for both agents, so that transfer between agents is the only option for changing these BPV values. Since the patient’s BPV entries are all zeros, transfer in the first time-step will only occur from HCW to patient. According to Table 2(b), bacteria in the HCW’s I-Cat = 1 entry can be transferred to all of the patient’s I-Cats with the exception of I-Cat = 3. If we set the probability for each of these possible transfers to 1.0 and set the proportion of bacteria transferred to 1%, then we should expect 100 bacteria to be transferred from the HCW’s I-Cat = 1 entry to each of the five possible patient recipient

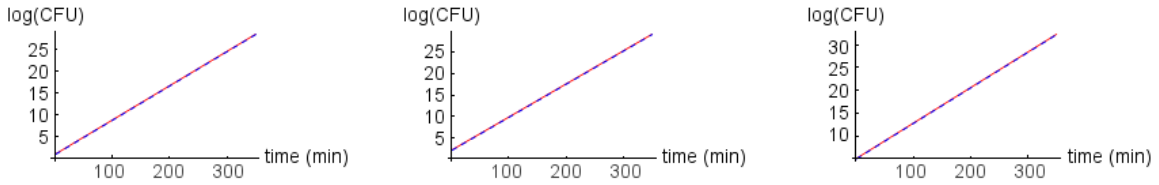

Figure 4: Test results for the intra-host DE model, in the absence of antibiotics, for sample agent’s three non-zero I-Cats. Red curves indicate the exact solutions of the DE system, and blue dashed curves indicate the numerical solutions provided by our MATLAB implementation.

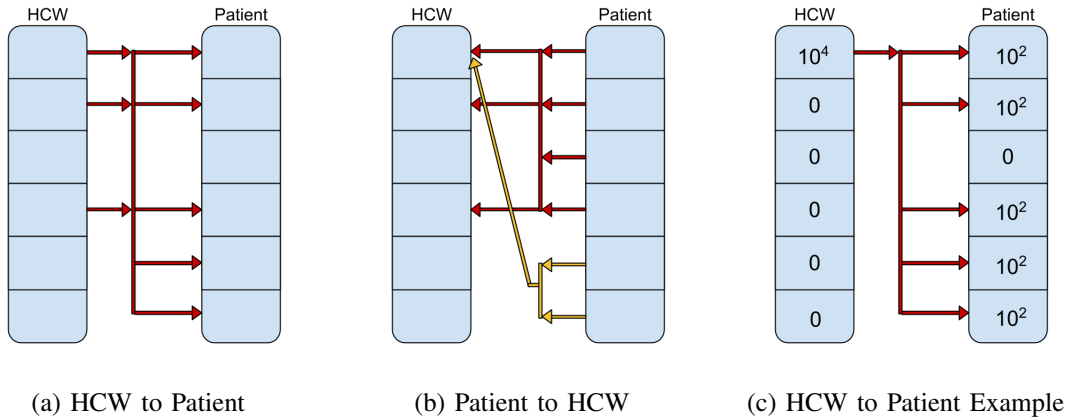

Figure 5: Possible bacteria transfers (a) from HCW to patient and (b) from patient to HCW. Experimental results are depicted in (c), where 10^2 (1%) of the HCW’s original 10^4 bacteria in the first entry are transferred to each of five of the patient’s I-Cat categories.

I-Cats. The resulting values generated by our implementation are depicted in Figure 5, and confirm that this aspect of our implementation is also operating correctly.

In our final test, we investigate the genetic mutation feature by once again considering a single agent, but with two antibiotics and two resistance-levels. Each of the agent’s I-Cats are now divided into four entries (because of the four possible resistance profiles, as illustrated in Figure 2), resulting in a BPV with 24 entries. For this test, we initially set $P_{1,1,2}$ (i.e., the second entry in the BPV) to 10^5 , and the rest to zero. Mutations within this sub-population will result in bacteria moving from $P_{1,1,2}$ to the other three resistance-profiles within I-Cat = 1, as shown in Figure 6. If we set the three related probabilities to the values indicated in Figure 6, our implementation generates the results shown. The number of mutants from $P_{1,1,2}$ into each of the other three sub-populations is consistent with expected values, thereby confirming that our implementation is handling mutations as intended.

We now demonstrate how our implementation may be used to explore resistance-control measures by using it to simulate the spread of hospital-acquired pneumonia (HAP) within an intensive care unit. HAP is the second most common hospital-acquired infection (after urinary tract infections), and a leading cause of HAI-induced mortality (Torres 2012). HAP is a particular problem within ICUs, where many patients undergo mechanical ventilation, which provides easy accessibility for pathogens to reach the lungs. The two most common pathogens implicated in HAP are *Staphylococcus aureus* and *Pseudomonas aeruginosa*, which together account for nearly one-third of cultured cases (Richards et al. 2000). Antibiotic resistant strains of both of these species (including the well-known *methicillin-resistant S. aureus*, or *MRSA*), are widespread, leading to the need for a large arsenal of antibiotics for treating HAP.

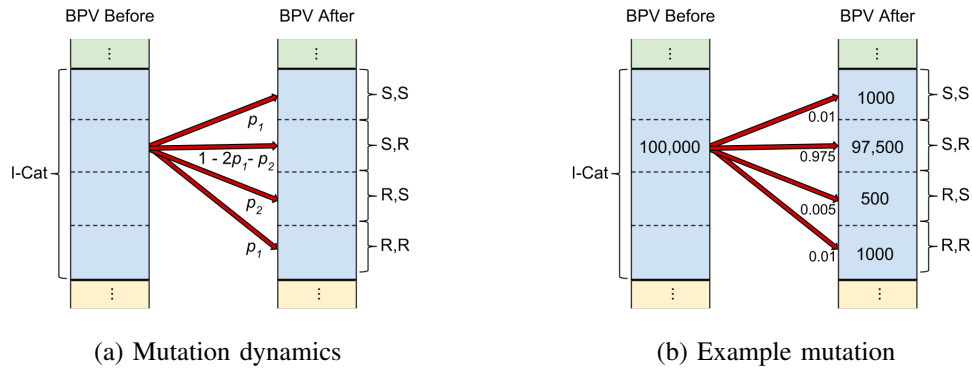

Figure 6: Bacteria mutation within an agent. This figure depicts one I-Cat within the BPV for a single agent before and after mutation, presuming one bacterium, two antibiotics, and two resistance levels.

Medical researchers have proposed that hospitals screen ICU patients at the first signs of pneumonia, to identify the specific infecting pathogen (Spellberg et al. 2008). Any resulting positive bacterial cultures would then be tested for their resistance levels (i.e., MIC values) with respect to the antibiotics most commonly used to treat them. The intention is to identify infections caused by resistant bacterial strains, and to avoid attempting to treat them with an ultimately ineffective drug. While this rationale is widely accepted as sound, in practice many hospitals will culture pneumonia patients only after the first attempt at antibiotic treatment has proven ineffective, reasoning that the procedure for obtaining sputum samples from the lung is not only unpleasant for the patient, but also provides an additional opportunity to introduce pathogenic bacteria into the patient’s lower respiratory system.

Our experiment will focus specifically on HAP caused by infection with *S. aureus*, and will compare two treatment strategies which differ only in the use of sputum culturing, as illustrated in Figure 7. In Treatment 1, patients are cultured only if the initial treatment with imipenem (a broad-spectrum antibiotic commonly used to treat pneumonia when the specific causative pathogen is not known) is not successful, resulting in a 24-hour lag time, compared to the immediate culturing of patients undergoing Treatment 2.

Figure 8 shows the results of two simulations. In the first simulation, both patients begin with 10^5 *S. aureus* bacteria, all susceptible to both imipenem and oxacillin, in I-Cat = 4 (the I-Cat that corresponds to pneumonia). One patient undergoes Treatment 1 while the other patient undergoes Treatment 2. As the first plot in Figure 8 illustrates, the bacterial load initially decreases identically in both patients (because both are receiving identical imipenem treatments – 500mg every six hours by IV injection). After 1440 minutes (24 hours), the Treatment 2 patient is changed to oxacillin, which proves to be more effective in reducing the *S. aureus* count. Ultimately, both patients are cured, although the Treatment 2 patient recovers more quickly.

In the second plot in Figure 8, the two patients are again identical, except each now has an infection with *S. aureus* that is resistant to imipenem and susceptible to oxacillin. For both patients, the bacterial load increases over the first 24 hours, at which time the Treatment 2 patient is switched to oxacillin therapy. At this point, the Treatment 1 patient is cultured, but must wait another 24 hours before lab results indicate a switch to oxacillin. Consequently, this patient’s bacterial load continues to increase, possibly to lethal levels, for an additional 24 hours. Even if the higher load is not lethal, Treatment 1 results in a longer time-to-recovery, which carries a correspondingly higher risk of tissue damage.

5 CONCLUSIONS AND FUTURE WORK

We have presented a new model for simulating the spread of antibiotic-resistant infections in hospital wards. This model combines an agent-based structure at the patient/HCW interaction level with a combination differential equations/probabilistic model at the intra-host level. We have demonstrated the ability of

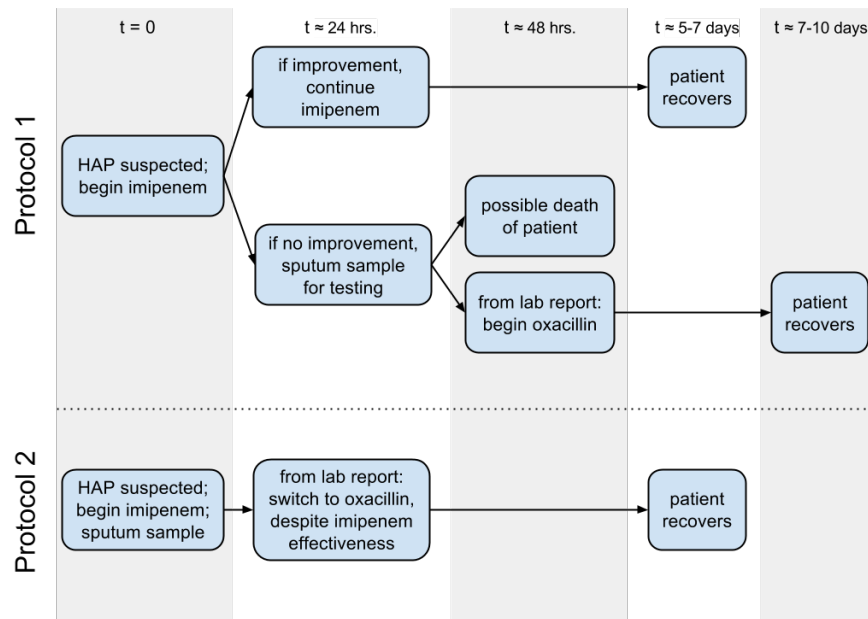

Figure 7: The two treatment protocols employed in the HAP simulation experiment.

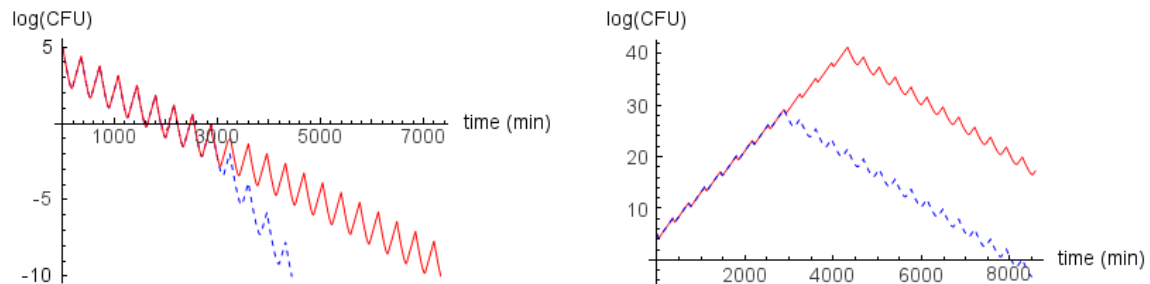

Figure 8: Results of HAP experiment, showing patient bacterial loads in $\log(CFU)$ versus time. Patients with infection susceptible to both imipenem and oxacillin are shown in the left plot, while the right plot shows those with infections that are resistant to imipenem but susceptible to oxacillin. In both plots, the patient under Treatment 1 is shown in solid red and the patient under Treatment 2 is shown in dashed blue.

this model to reproduce the basic bacterial and infection dynamics upon which the model is based. We demonstrated the potential usefulness of this model by investigating two different treatment strategies for pneumonia caused by *S. aureus*.

In future work, we will extend this model to incorporate additional factors including:

- *Agent self-interaction events*: It is often the case that a bacteria species can be harmless in some agent I-Cats but pathogenic in other I-Cats. It is possible, e.g., through inadequate personal hygiene, to induce infection in oneself by transferring such bacteria from a “safe” I-Cat to a less-safe one. We will extend the model to include an event type for agents interacting with themselves, to permit the transfer of bacteria between I-Cats of a single agent.
- *Immune system effects*: The immune response to bacterial infection has a great impact on the course of the infection. In fact, it has been postulated that immunocompromised patients (e.g., the elderly, and patients in oncology wards or transplant wards) may play an important role in the ability of

antibiotic-resistant pathogens to survive long-term in hospitals (Moellering and Blumgart 2002). We will extend our model to include bacteria-immune system interactions (Caudill 2013).

- *Indicators of infection severity*: Our model currently uses bacteria counts to measure infection severity. In practice, these numbers are seldom known, and clinicians rely on indirect measures of infection severity, including body temperature and white blood cell count. We will investigate the relationship between these quantities and bacterial load to incorporate these indirect signs, thereby permitting us to more-closely parallel the usual patterns of antibiotic therapy.
- *Agent mortality*: Currently there is no mechanism whereby an agent can die from infection, regardless of how large the pathogen load becomes. We will incorporate a mechanism whereby mortality will become possible for agents with very high bacterial loads in the most sensitive I-Cats.
- *Antibiotic toxicity*: Any antibiotic, in sufficiently-high concentrations, will be toxic to humans. We will incorporate the effects of antibiotic toxicity into our model to more accurately reflect the limitations faced by prescribing medical personnel.
- *Complicating physical conditions (e.g., kidney failure)*: There is a significantly greater risk of toxic reactions to antibiotics in individuals with certain physical conditions, such as reduced kidney function. We will extend our model to permit varying degrees of kidney function among the agents to investigate the effect on the spread of antibiotic resistance.

ACKNOWLEDGMENTS

The authors acknowledge the support of the University of Richmond Summer Research Fellowship program.

REFERENCES

- Barnes, S., B. Golden, and E. Wasil. 2010. "MRSA Transmission Reduction Using Agent-Based Modeling and Simulation". *INFORMS Journal on Computing* 22 (4): 635–646.
- Bootsma, M., O. Diekmann, and M. Bonten. 2006. "Controlling methicillin-resistant *Staphylococcus aureus*: Quantifying the effects of interventions and rapid diagnostic testing". *Proceedings of the National Academy of Sciences* 103 (14): 5620–5625.
- Caudill, L. 2013. "A Single-Parameter Model of the Immune Response to Bacterial Invasion". *Bulletin of Mathematical Biology*. DOI 10.1007/s11538-013-9854-1.
- Chamchod, F., and S. Ruan. 2012a. "Modeling methicillin-resistant *Staphylococcus aureus*: transmission dynamics, antibiotic usage and its history". *Theoretical Biology and Medical Modeling* 9 (25).
- Chamchod, F., and S. Ruan. 2012b, January. "Modeling the Spread of Methicillin-Resistant *Staphylococcus aureus* in Nursing Homes for Elderly". *PLOS One* 7 (1): e29757.
- D'Agata, E., G. Webb, and M. Horn. 2005. "A Mathematical Model Quantifying the Impact of Antibiotic Exposure and Other Interventions on the Endemic Prevalence of Vancomycin-Resistant Enterococci". *Journal of Infectious Diseases* 192:2004–2011.
- Djanatljev, A., R. German, P. Kolominsky-Rabas, and B. M. Hofmann. 2012, December. "Hybrid Simulation with Loosely Coupled System Dynamics and Agent-Based Models for Prospective Health Technology Assessments". In *Proceedings of the 2012 Winter Simulation Conference*, edited by C. Laroque, J. Himmelspach, R. Pasupathy, O. Rose, and A. Uhrmacher. Berlin: IEEE.
- Farr, B., C. Salgado, T. Karchmer, and R. Sherertz. 2001, August. "Can antibiotic-resistant nosocomial infections be controlled?". *Lancet Infectious Diseases* 1 (1): 38–45.
- Goldmann, D., R. Weinstein, R. Wenzel, O. Tablan, R. Duma, R. Gaynes, J. Schlosser, and W. Martone. 1996, January. "Strategies to Prevent and Control the Emergence and Spread of Antimicrobial-Resistant Microorganisms in Hospitals". *JAMA* 275 (3): 234–240.
- Helbing, D., and S. Baliatti. 2011. "How to Do Agent-Based Simulations in the Future: From Modeling Social Mechanisms to Emergent Phenomena and Interactive Systems Design". Technical Report 2011-06-024,

- Santa Fe Institute, Santa Fe, New Mexico. Available via <http://www.santafe.edu/media/workingpapers/11-06-024.pdf> [accessed 1 July 2013].
- Klevens, R., J. Edwards, C. Richards, T. Horan, R. Gaynes, D. Pollock, and D. Cardo. 2007, March-April. "Estimating Health Care-Associated Infections and Deaths in U.S. Hospitals, 2002". Technical Report Vol. 122. Centers for Disease Control and Prevention (CDC) Public Health Report.
- Leemis, L. M., and S. K. Park. 2006. *Discrete-Event Simulation: A First Course*. Upper Saddle River, New Jersey: Pearson Prentice Hall.
- Macal, C. M., M. J. North, N. T. Collier, V. M. Dukic, D. S. Lauderdale, M. Z. David, R. S. Daum, P. Shumm, R. S. Daum, J. A. Evans, J. R. Wilder, and D. T. Wegener. 2012, December. "Modeling the Spread of Community-Associated MRSA". In *Proceedings of the 2012 Winter Simulation Conference*, edited by C. Laroque, J. Himmelspach, R. Pasupathy, O. Rose, and A. Uhrmacher. Berlin: IEEE.
- Meng, Y., R. Davies, K. Hardy, and P. Hawkey. 2010. "An application of agent-based simulation to the management of hospital-acquired infection". *Journal of Simulation* 4:60–67.
- Moellering, R., and H. Blumgart. 2002. "Understanding antibiotic resistance development in the immunocompromised host". *International Journal of Infectious Diseases* 6:S3–S4.
- Rahmandad, H., and J. Sterman. 2008, May. "Heterogeneity and Network Structure in the Dynamics of Diffusion: Comparing Agent-Based and Differential Equation Models". *Mgt Sci* 54 (5): 998–1014.
- Richards, M. J., J. R. Edwards, D. H. Culver, and R. P. Gaynes. 2000. "Nosocomial Infections in Combined Medical-Surgical Intensive Care Units in the United States". *Inf Cont Hosp Epid* 21:510–515.
- Sievert, D. M., P. Ricks, J. R. Edwards, A. Schneider, J. Patel, A. Srinivasan, A. Kallen, B. Limbago, and S. Fridkin. 2013, January. "Antimicrobial-Resistant Pathogens Associated with Healthcare-Associated Infections: Summary of Data Reported to the National Healthcare Safety Network at the Centers for Disease Control and Prevention, 2009-2010". *Inf Cont Hosp Epid* 34 (1): 1–14.
- Smith, D., J. Dushoff, E. Perencevich, A. Harris, and S. L. SA. 2004. "Persistent colonization and the spread of antibiotic resistance in nosocomial pathogens: Resistance is a regional problem". *Proceedings of the National Academy of Sciences* 101 (10): 37093714.
- Spellberg, B., R. Gidycz, D. Gilbert, J. Bradley, H. Boucher, W. Scheld, J. Bartlett, and J. Edwards. 2008. "The Epidemic of Antibiotic-Resistant Infections: A Call to Action for the Medical Community from the Infectious Diseases Society of America". *Clinical Infectious Diseases* 46:155–164.
- Stein, G. 2005. "Antimicrobial resistance in the hospital setting: impact, trends, and infection control measures". *Pharmacotherapy* 25 (10): 44S–54S.
- Torres, A. 2012. "Antibiotic Treatment Against Methicillin-Resistant Staphylococcus aureus Hospital- and Ventilator-acquired Pneumonia: A Step Forward but the Battle Continues". *Clinical Infectious Diseases* 54:630–632.

AUTHOR BIOGRAPHIES

LESTER CAUDILL is an Associate Professor of Mathematics in the Department of Mathematics and Computer Science at the University of Richmond. He received Ph.D. and B.S. degrees in Mathematics from Texas A&M University. His research interests include mathematical modeling and biomedical applications. His email address is lcaudill@richmond.edu and his Web page is <http://www.mathcs.richmond.edu/~lcaudill/>.

BARRY LAWSON is an Associate Professor of Computer Science in the Department of Mathematics and Computer Science at the University of Richmond. He received Ph.D. and M.S. degrees in Computer Science from The College of William and Mary, and a B.S. degree in Mathematics and Computer Information Systems from UVA's College at Wise. His research interests include agent-based simulation and computer security, and he is a member of ACM and IEEE. He previously worked in the Simulation Systems Branch at NASA Langley in Hampton, VA. His email address is blawson@richmond.edu and his Web page is <http://www.mathcs.richmond.edu/~blawson/>.